

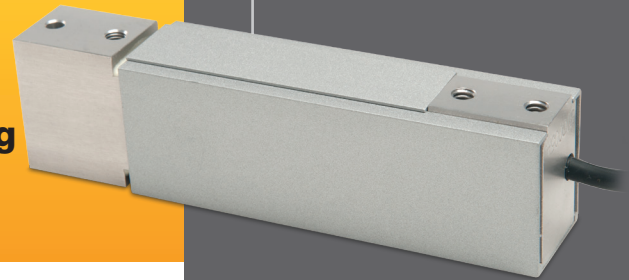

Single Point Load Cell

YD6 Series

The YD Series is a low profile, high performance, strain gage load cell constructed of aluminum alloy. It is designed to accurately measure compression loads in capacity ranges of 0-5 kg to 0-100 kg.



The YD Series is a low profile, high performance strain gage load cell constructed of transducer-quality aluminum alloy. The YD Series is designed to accurately measure compression loads ranging from 0-5 kg to 0-100 kg. Developed specifically to tolerate unusually high moments resulting from off-center loading in single load cell platform applications, this design has been adapted to small hopper applications such as loss-in-weight and net weighing. The YD Series unique beam construction and element geometry delivers exceptional performance and readily tolerates moments induced by angular, eccentric and off-center loading, with minimal sensitivity to these anomalies. This load cell is Hostile Environment Sealed (IP66-High Pressure Jets) by virtue of proprietary, multi-redundant barriers uniquely integrated to protect all internal components. The cable is a durable polyurethane-jacketed cable, with a tinned-copper braided shield for mechanical protection and to minimize the effects of RFI and EMI. The YD Series is particularly well suited to low force measurements as well as O.E.M. weighing applications in packaging, filling, bottling and any situation where a moment-compensated, well sealed, high performance load cell solution is required.



APPLICATIONS

- Compression Measurements
- Low Force Measurements
- Hopper and Net Weight Weighing
- Platform and Belt Conveyor Scales
- High Moment/Off-Center Loads
- Harsh Environments
- OEM and VAR Solutions

FEATURES

- 5 kg to 100 kg Capacities
- Low Profile/Compact Size
- 0.02% Accuracy Class - NTEP Grade
- Application Versatility
- Aluminum Alloy
- IP66 Environmental Sealing
- High Temperature Versions
- Two Year Warranty

For more information call **1-888-545-8988**

SENTRAN, LLC 4355 LOWELL STREET, ONTARIO, CA 91761, U.S.A.
888-545-8988 T: 909-605-1544 FAX: 909-605-6305 www.sentranllc.com

YD6 Series Specifications

Innovative Measurement Solutions



PERFORMANCE

Rated Capacities (kg)	5, 7, 10, 15, 20, 30, 50, 60, 75, 100
Rated Output (FSO)	2 mV/V
Output Tolerance	±10 % R.O
Combined Error Band	≤ 0.02 % FSO
Non-Linearity	≤ 0.02 % FSO
Hysteresis	≤ 0.02 % FSO
Non-Repeatability	≤ 0.01 % FSO
Zero Balance	± 5 % FSO (YD6)
Creep (30 Minutes)	≤ 0.03 % of load
Zero Return (30 Minutes)	0.01 % of load
Moment Sensitivity	0.019 % FSO/Inch 0.0025 % FSO/Inch (≥ 100 kg)
Maximum Moment	See Dimensions Page
Ultimate Moment	175 % of Maximum Moment

MECHANICAL

Load Cell Material	Aluminum Alloy
Load Cell Finish	Anodized
Safe Overload	Compression 150% FSO Side Load 50% FSO
Ultimate Overload	Compression 300% FSO Side Load: 100% FSO
Deflection	See Dimensions Table
Weight	See Dimensions Table
Mounting Bolt Torque	Torque Table

ELECTRICAL

Input Impedance	385 ± 15 ohms
Output Impedance	350 ± 3 ohms
Insulation Resistance	>5000 Megohms @ 50VDC
Excitation Voltage	10 V AC/DC (15 V maximum)
Cable Color Code	+ Excitation (Red) - Excitation (Black) + Signal (Green) - Signal (White) Shield (Natural)
Cable Type	6-conductor, 22 AWG, PVC jacket, Tinned Copper Braided Shield, Diameter: 0.200"
Cable Length	See Dimensions Table
Cable Termination	Finished Conductors
Cable Seal	Epoxy Conformal Seal

ENVIRONMENTAL

Temperature, Operating	0 to +150 °F (-18 to +66°C)
Temperature, Compensated	14 to +104 °F (-10 to +40°C)
Temperature Effects	Zero < 0.0015% FSO/°F < 0.0026% FSO/°C
Temperature Effects	Output < 0.0008% FSO/°F < 0.0014% FSO/°C
Temperature, Storage	-40 to +170 °F (-40 to +77°C)
Sealing	IP66, Multi-redundant; High Pressure Resistant
FM Approval	Intrinsically Safe: Class I, II, III; Div.1 Groups A-G Non-Incendive: Class 1; Div.2 Groups A-D

YD6 Typical System Configuration

SENSING LOAD CELL(S)

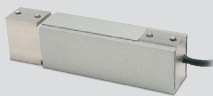

SIGNAL CONDITIONING

Analog Transmitters



Serial Transmitter



Digital Indication



Process Control



Batch Control



Data Acquisition



OUTPUT OPTIONS

- 0-5 VDC
- 0-10VDC
- ±5 VDC
- ±10 VDC
- 4-20 mA
- 0-20 mA
- RS-232
- RS-422
- RS-485
- 20 mA Serial Loop
- Ethernet
- Profibus DP
- DeviceNet
- CANOpen
- ControlNet
- Modbus RTU
- Wireless

www.sentranllc.com

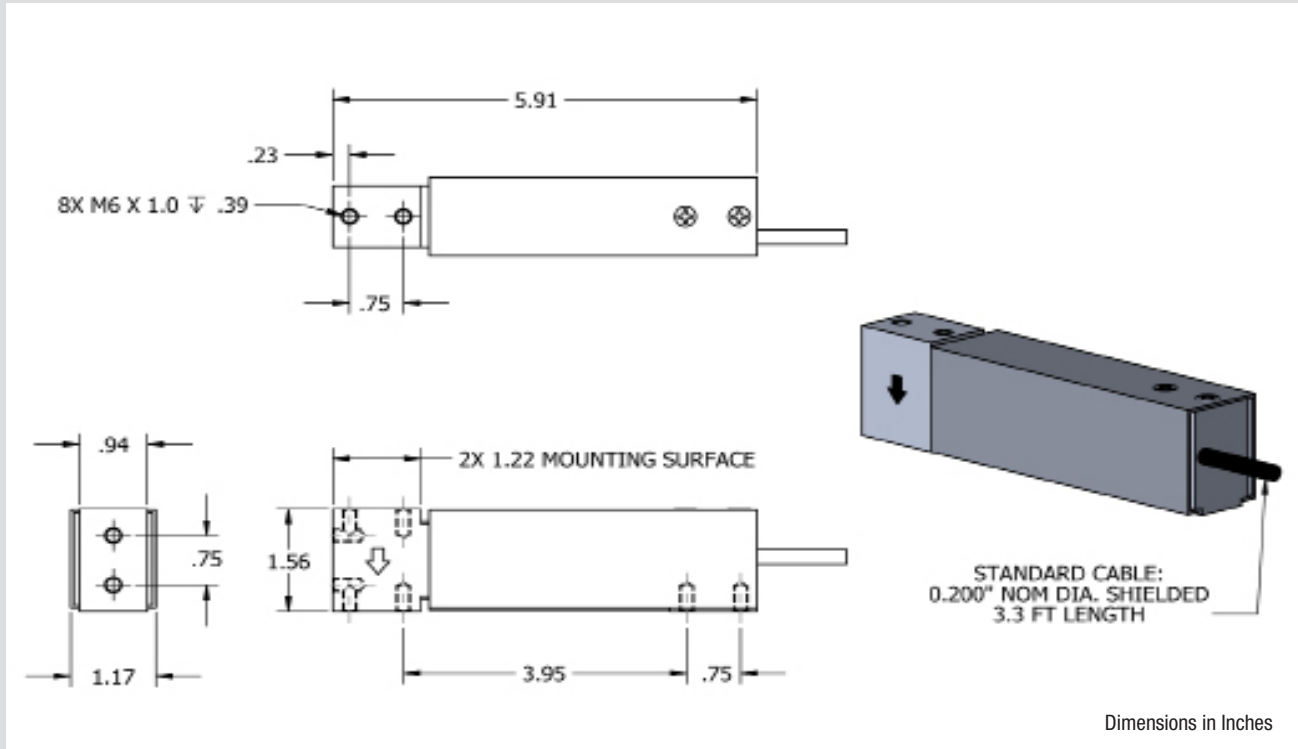

Dimensions in Inches

Capacity (KG)	Maximum Moment (Inches X Capacity)	Deflect	Weight
5	6	0.012"	1.0 LB
7	6	0.012"	1.0 LB
10	6	0.012"	1.0 LB
15	6	0.012"	1.0 LB
20	6	0.012"	1.0 LB
30	6	0.015"	1.0 LB
50	6	0.015"	1.0 LB
100	6	0.015"	1.0 LB

YD6 Wiring Diagram

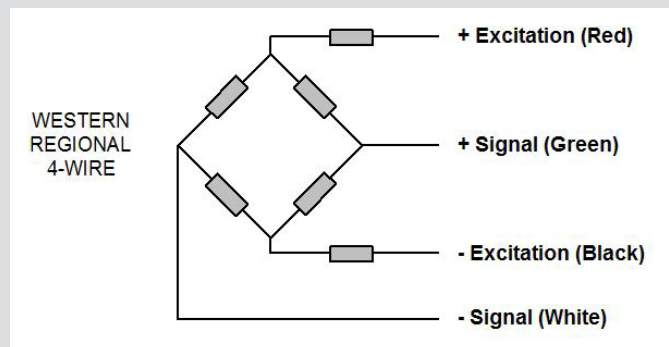



Loss-In-Weight Hopper



Loss-In-Weight



Gravimetric Multi-Component Feeder

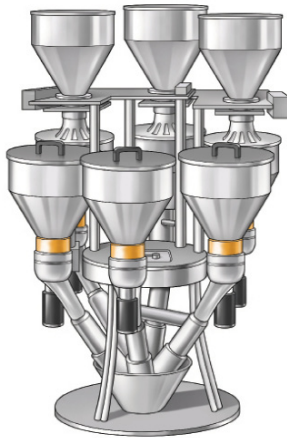

Net Weighing

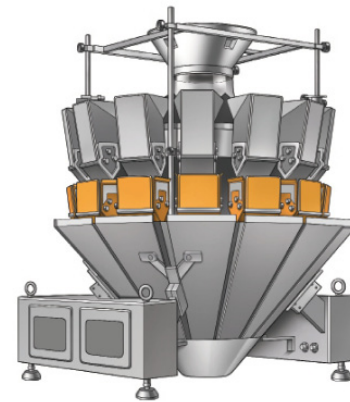

Precious Gas Scale



Bottle/Tank Platform Weighing

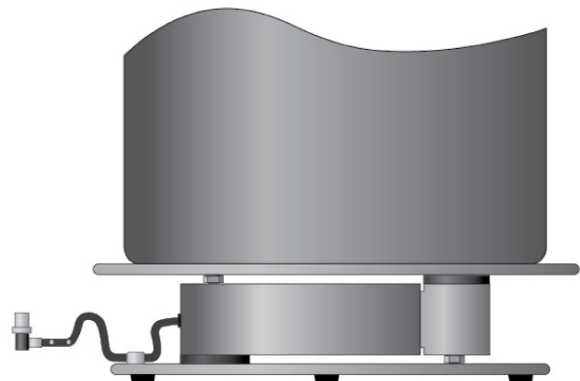



- High Temperature Operation (to 400°F)
- In-Line Analog or Serial Transmitters
- Display/Control Instrumentation
- Junction/Summing Boxes
- Wireless Operation
- MS Connectors
- Shunt Calibration
- Use and Installation Guide
- Custom and OEM Solutions

Application Recommendations / Suggestions

- The Y Series Load Cells are designed for compression force measurement applications. These load cells were developed specifically to tolerate unusually high moments resulting from off-center loading in single load cell platform applications. Subsequently, the unique characteristics of this design lend to its adaptation to small hopper applications, monorail scales, belt conveyor scales and packaging machine applications, to name a few. The Y Series unique element geometry delivers exceptional performance and readily tolerates moments induced by angular, eccentric and off-center loading, with minimal sensitivity to these anomalies.
- Y Series load cells are cantilever beams, meaning they are rigidly fixed on a suitable mounting surface on one end and the load is introduced to the opposite end of the beam. The most common loading methods are via a bolt-on platform or bracket.
- For optimum performance the load cell should be securely mounted to a flat, rigid surface. Some Y Series load cells have built-in mounting bosses, while others require spacers that serve to define the beam reaction point and provide clearance for the load cell to deflect freely. Similar provisions are required for the loading end as well.
- Y Series load cells are generally available in relatively low capacity ranges. The advantage is their ability to resolve very low forces. This excellent sensitivity also makes the load cell more susceptible to unintended overloads, often caused by mishandling. Therefore care must be taken when handling, installing and using these load cells to guard against overloading, which in many cases can render the load cell unusable. Some versions incorporate integral overload protection for compression, tension, or both. Commonly, overload protection is incorporated in an given application to protect the load cell from excessive deflection due to static or dynamic force inputs.
- Moment compensated load cells have specific maximums for moment sensitivity and moment tolerance. These published specifications should never be exceeded. Maintaining a center of gravity as close to centerline as possible is always preferable.
- These load cells are designed to be used over the complete range of “no load” (0) up to the rated capacity. For example, 10 lbs. rated capacity Y Series load cells are designed to be used for measurements within the range of 0 to 10 lbs. These load cells can be safely loaded to 150% of rated capacity without affecting the load cell performance within the capacity range.
- The reason for the variety of capacities and configurations is to allow the user to select the most ideal capacity, geometry and sealing level for a given application. The most ideal capacity is one in which at least 80% of the capacity range is utilized at some point in the measurement process, without exceeding the rated capacity. This allows the load cell to deliver the highest signal to load ratio, and therefore the highest resolution and most stable measurement. There are other factors to consider, such as excitation voltage, but correct “sizing” of the load cell is the first step. Both the dead load and the live load need to be considered in determining the gross load and the load cell capacity.
- Contact Sentran’s expert Applications Specialists for additional professional guidance and technical support documentation.

Commercial Information & Precautions

- Do not exceed specified Maximum Load Limits.
- The Safe Load Limit is the point to which normal loading will not cause the load cell to experience an excessive zero shift or a degradation in performance.
- Use reasonable care when applying load to any load cell. Load limits can be exceeded due to shock loading (i.e. dropping a load onto a load cell), off axis loading, side loading and similar loading conditions that are beyond design capabilities.
- The structural integrity of all load bearing components in any load cell system should be designed with safety redundant load paths. (Overload stops, overhead load arrestors, etc.)
- The surfaces to which the load cell(s) is attached and/or is reacting against must be of sufficient structural integrity to carry loads up to and exceeding the ultimate ratings of the load cell(s) being used, while also taking into account any companion hardware being used in conjunction with the load cell.
- To ensure optimum performance, all measuring system cabling should be run through dedicated conduit when available. Avoid proximity to electrical noise sources and use of “dirty” power sources.
- The load cell cable shield should be connected to a dedicated instrument ground point only.
- Force measurement and weighing applications have numerous application-specific considerations to be addressed both mechanically and electrically. Therefore, installation of all system components are the responsibility of the user and should always be approved by a qualified, professional engineer. Any information provided by Sentran, LLC is intended only as informational and does not constitute a formal recommendation for the use of any product for any application.
- Sentran offers application/installation/use guides on request for most standard products. Please contact your Sentran representative for assistance, or visit our technical library resource at www.sentranllc.com.

Legal Disclaimer



ALL PRODUCTS, PRODUCT SPECIFICATIONS AND DATA ARE SUBJECT TO CHANGE WITHOUT NOTICE.

Sentran, LLC, Incorporated, its affiliates, agents, and employees, and all persons acting on its or their behalf (collectively, “Sentran, LLC”), disclaim any and all liability for any errors, inaccuracies or incompleteness contained herein or in any other disclosure relating to any product. The product specifications do not expand or otherwise modify Sentran, LLC’s terms and conditions of purchase, including but not limited to, the warranty expressed therein. Sentran, LLC makes no warranty, representation or guarantee other than as set forth in the terms and conditions of purchase. To the maximum extent permitted by applicable law, Sentran, LLC, disclaims (i) any and all liability arising out of the application or use of any product, (ii) any and all liability, including without limitation special, consequential or incidental damages, and (iii) any and all implied warranties, including warranties of fitness for particular purpose, non-infringement and merchantability. Information provided in datasheets and/or specifications may vary from actual results in different applications and performance may vary over time. Statements regarding the suitability of products for certain types of applications are based on Sentran, LLC’s knowledge of typical requirements that are often placed on Sentran, LLC products. It is the customer’s responsibility to validate that a particular product with the properties described in the product specification is suitable for use in a particular application. No license, express, implied, or otherwise, to any intellectual property rights is granted by this document, or by any conduct of Sentran, LLC. The products shown herein are not designed for use in life-saving or life-sustaining applications unless otherwise expressly indicated. Customers using or selling Sentran, LLC products not expressly indicated for use in such applications do so entirely at their own risk and agree to fully indemnify Sentran, LLC for any damages arising or resulting from such use or sale. Please contact authorized Sentran, LLC personnel to obtain written terms and conditions regarding products designed for such applications.



SENTRAN, LLC
4355 LOWELL STREET
ONTARIO, CA 91761-2225, U.S.A.
T: 909-605-1544 F: 909-605-6305
www.sentranllc.com

Innovative Measurement Solutions